

Boden / bottom

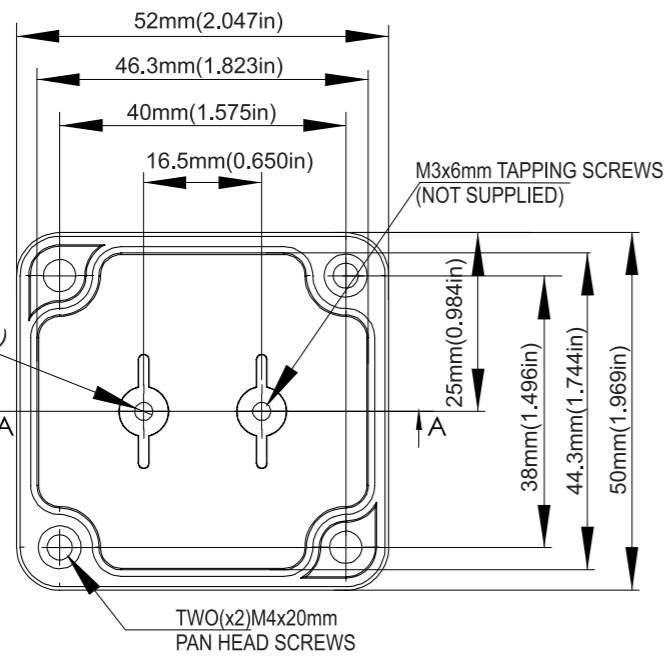

Deckel / cover

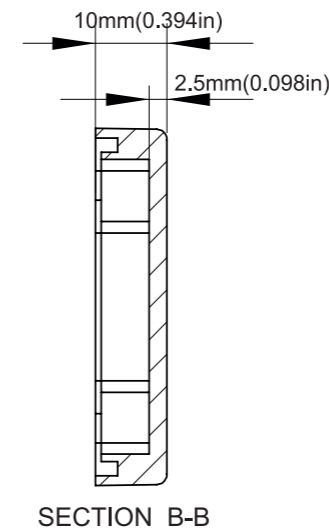
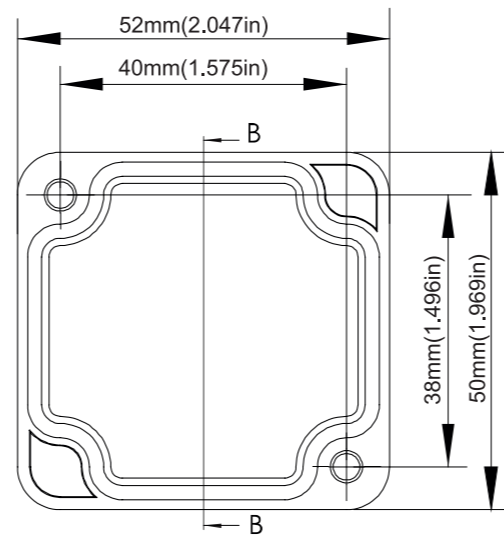

Dichtung/sealing

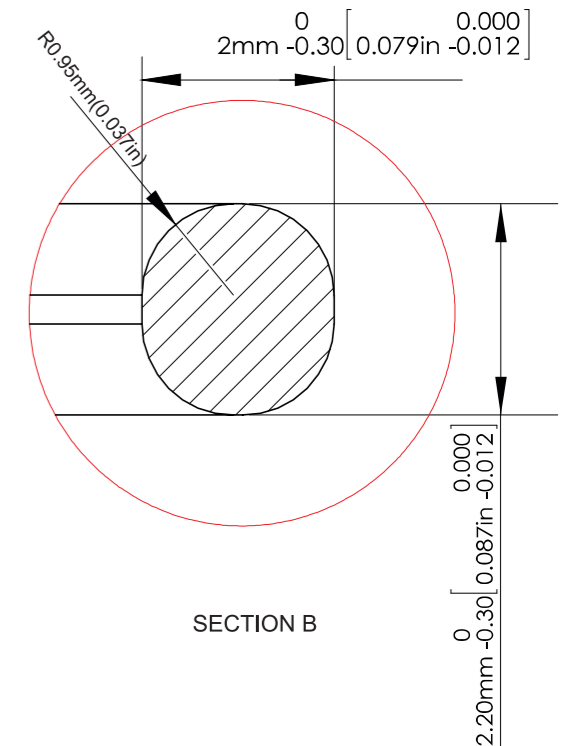
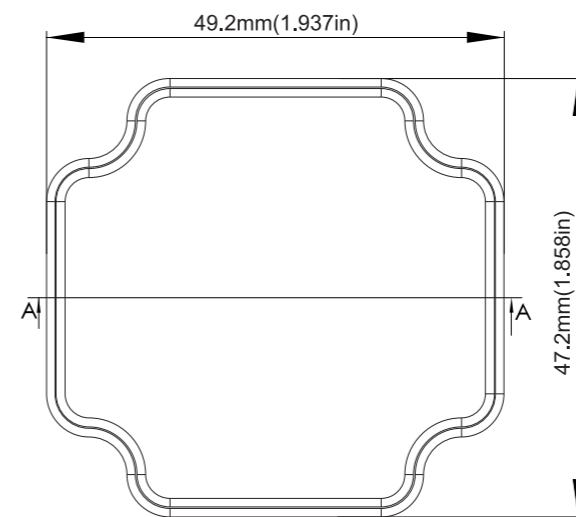
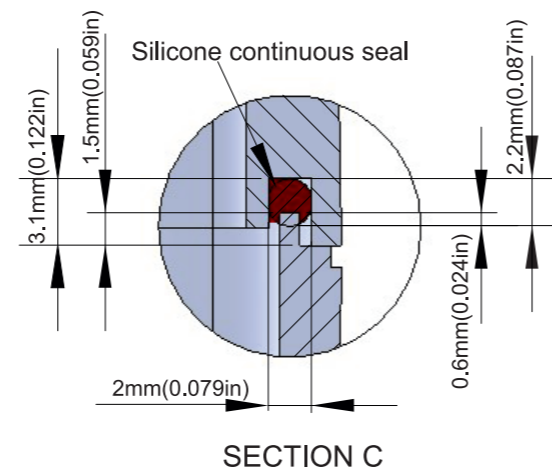
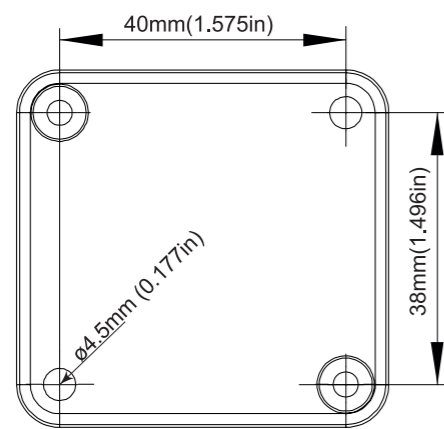

Boden / bottom

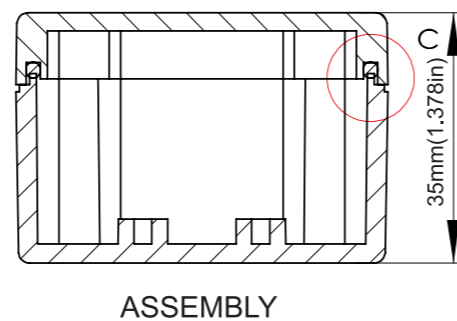
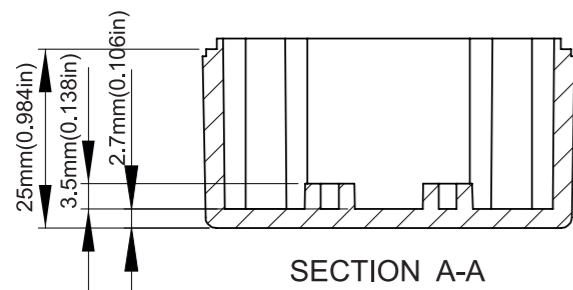

According to ISO 2768-m

Measuring DIM=L	Tolerances
0.5<L<=3.0mm	±0.1mm
3.0<L<=6.0 mm	±0.1mm
6.0<L<=30.0 mm	±0.2mm
30.0<L<=120.0 mm	±0.3mm
120.0<L<=400.0 mm	±0.5mm
400.0<L<=1000.0 mm	±0.8mm

**RICHARD WÖHR**  
GMBH

Gräfenau 58-60  
D-75339 Höfen / Enz

Telefon (07081) 9540-0  
Telefax (07081) 9540-90  
Richard@WoehrGmbh.de  
www.WoehrGmbh.de

**Bezeichnung: /Expression**  
**Industriegehäuse**  
**industrial enclosure**

**Artikel-Nummer:**

**GH02KS002/120IP68**  
**GH02KS002/520IP68**

Maße in mm  
dimensions  
are in mm

Version:  
26.05.2020