

Wandbefestigung

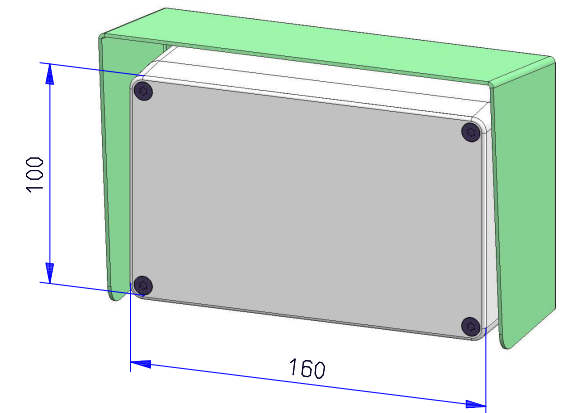
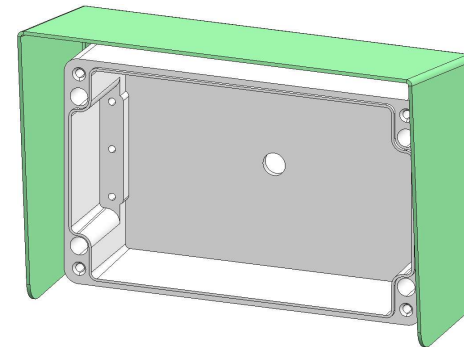
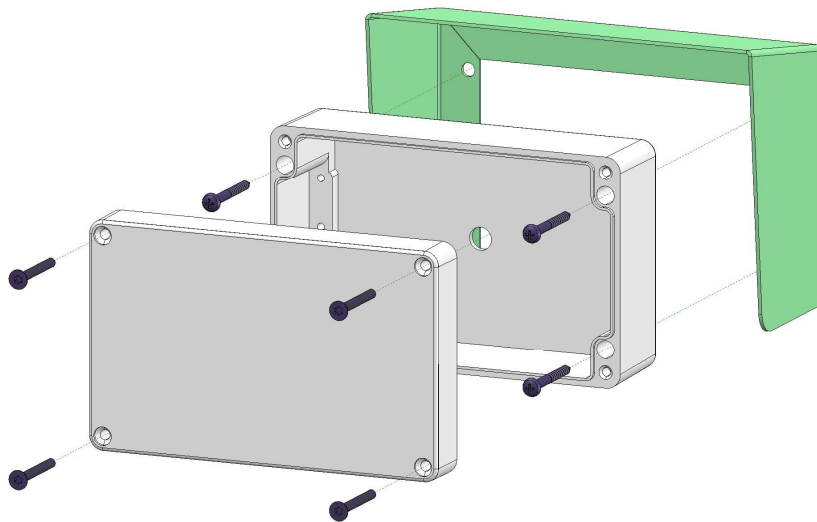

Lieferung ohne Befestigungssatz

 www.WoehrGmbH.de	Refer to protection notice ISO 16016 General tolerances ISO 2768 medium Not measured outlines take from the 3D- or dxf-data		Maßstab: 1:2,2	Gewicht:
			Baugruppe: GH02AL001/065	Kunde: 169999
			Bezeichnung: Wetterdach Type 2	
			Artikel-Nr.: GH02AL001_065-WD2	
			Material: EN 1.4301 1,5mm	
				Blatt 1
				Bl.
Zust.	Aenderung	Datum	Name	Urspr.
				Ers. I: