

Standardgehäuse 3 Modul

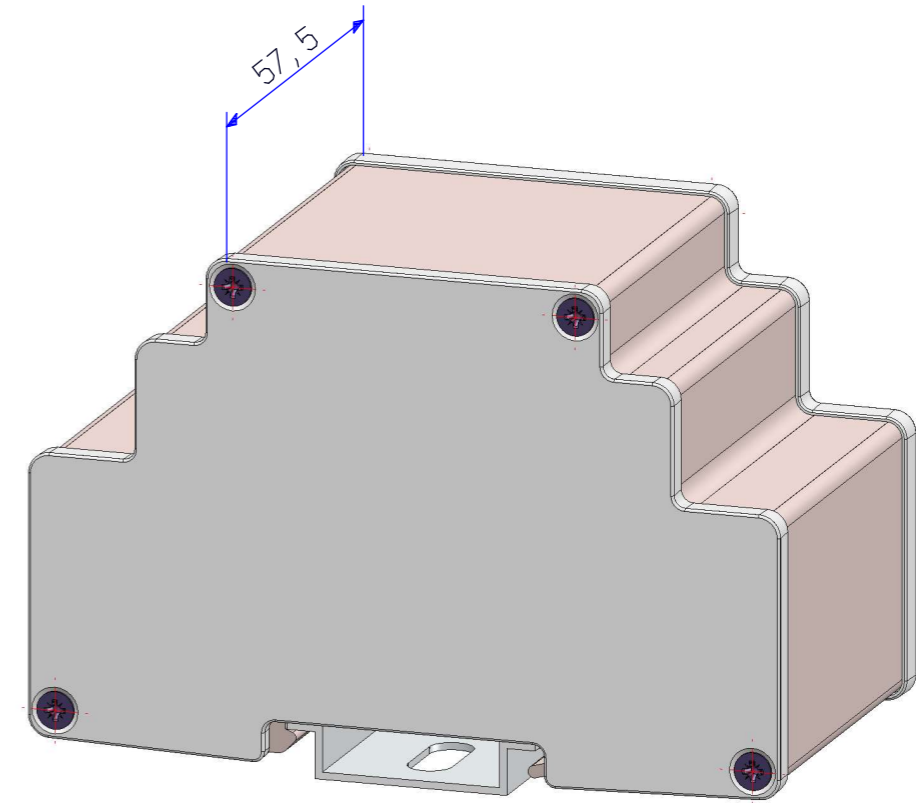
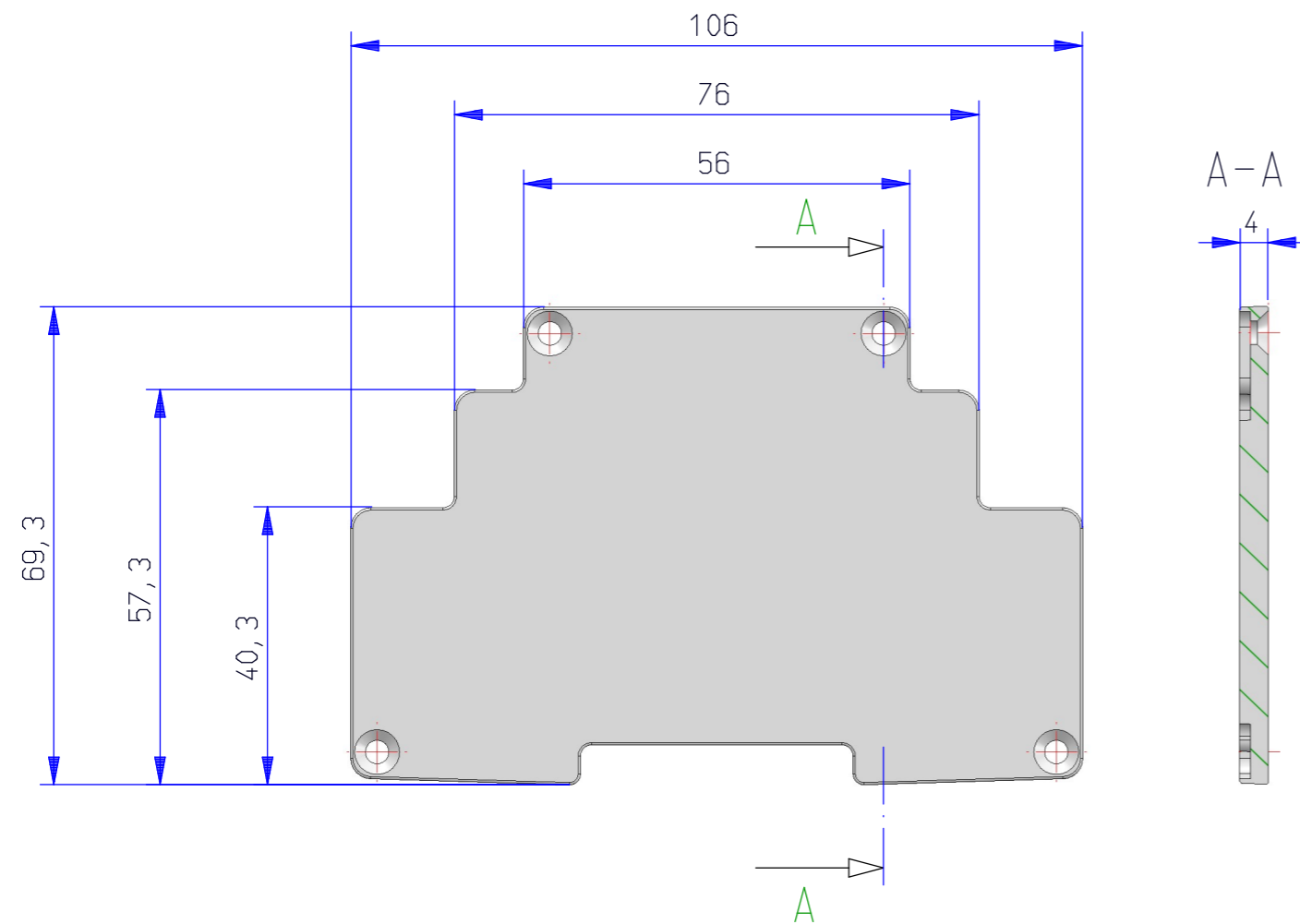
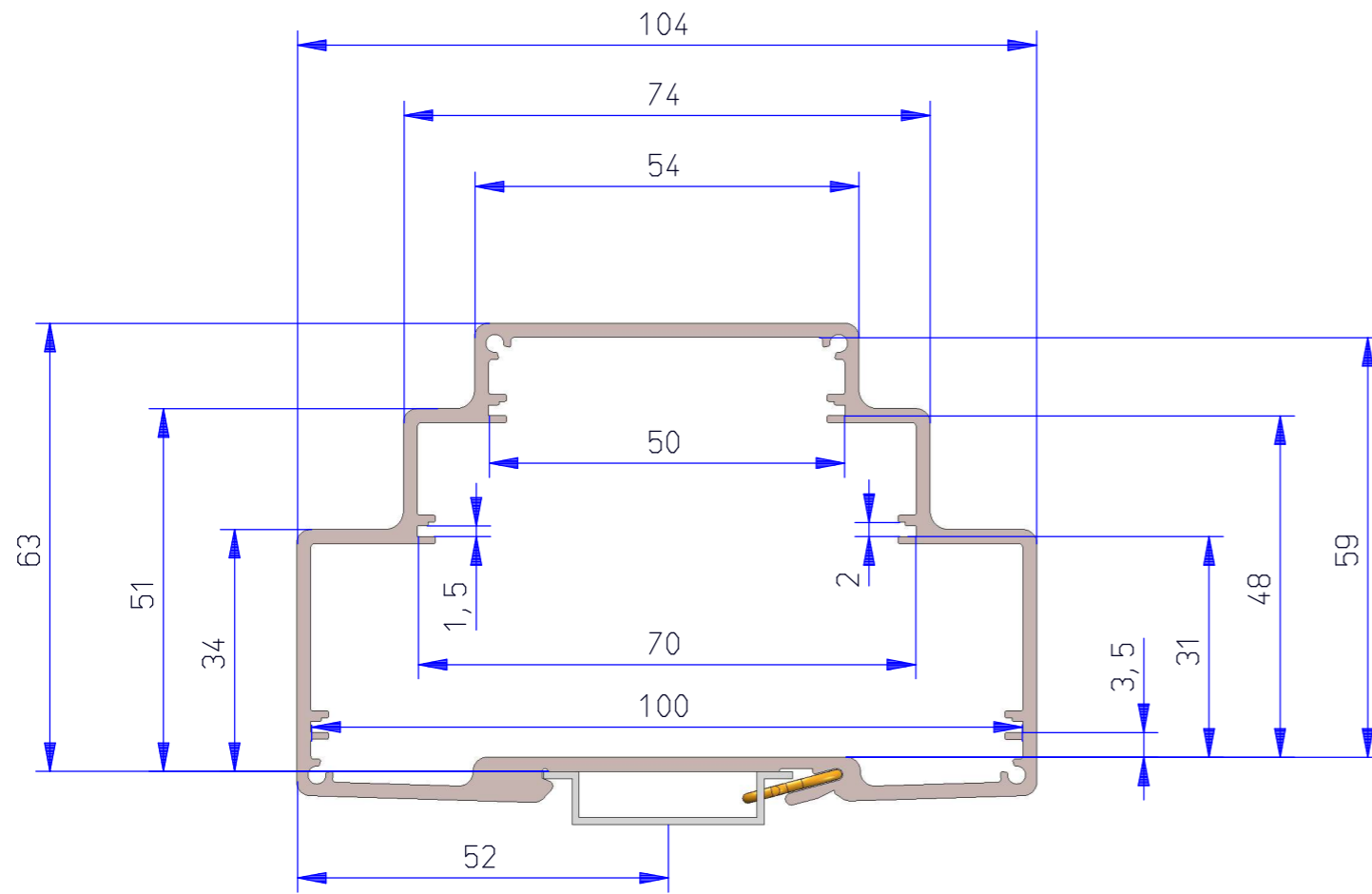

Oberfläche (X): Code RAL z.B. RAL9005 = 9005
(Standard Farben: RAL9005 und RAL7035)

 www.WoehrGmbH.de		Maßstab: 1:1		Gewicht:	
Schutzvermerk nach DIN 16016 beachten / Freimasstoleranzen nach DIN 2768 mittel Not measured outlines take from the 3D- or dxf-data					
		Datum		Name	
		Bearb. 23.01.2017		M.Erlenmaier	
		Gepr. 23.01.2017		A.Schiele	
		Norm			
Richard Wöhr GmbH D-75339 Höfen / Enz Richard@WoehrGmbH.de				Baugruppe	
				Kunde	
				DinRa	
				169999	
				DinRa_00525_X	
				Material	
				Blatt	
				1	
				Bl.	
Zust.	Änderung	Datum	Name	Urspr.	Ers. f. / Ers. d.